

5.

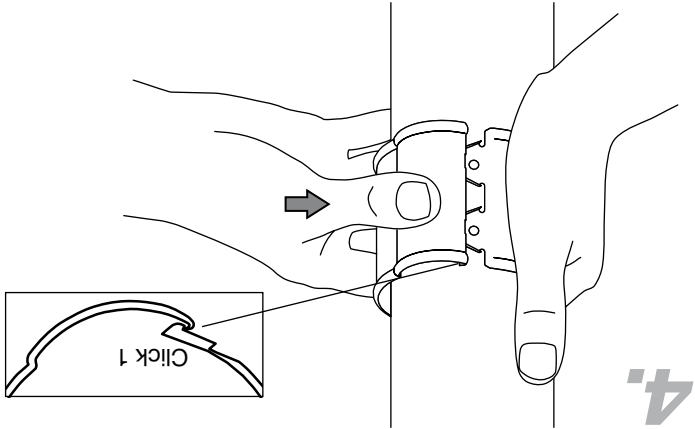

4.

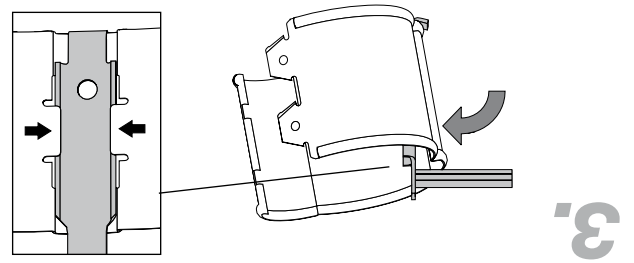

3.

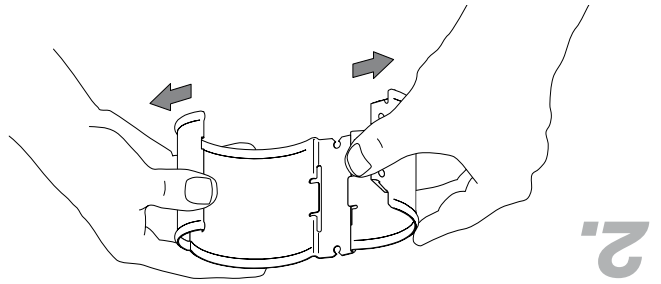

2.

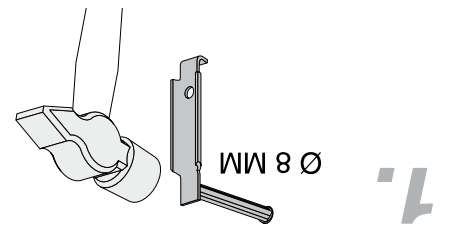

1.



lindab rainline | assembly instruction

indab rainline | assembly instruction

SSV+SST

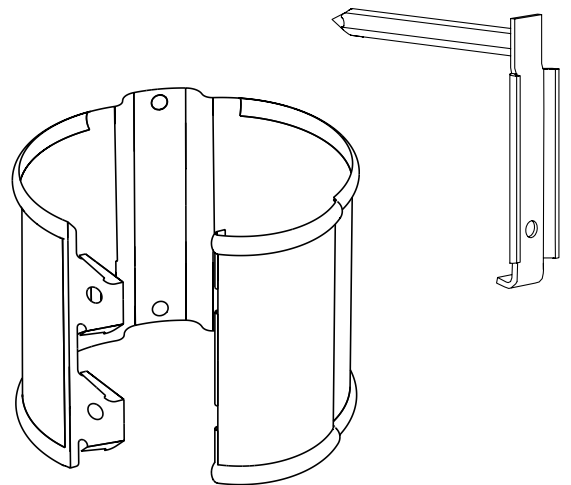
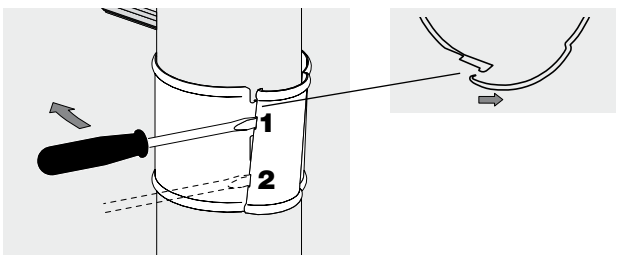
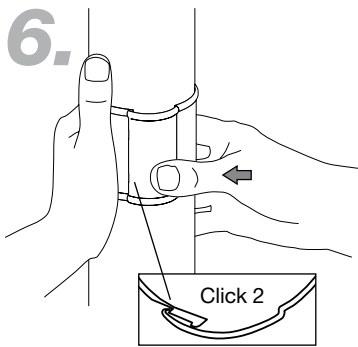

Art no 410614 2008-09-08



Lindab Profil AB
SE-269 82 Båstad
Phone +46 431 850 00
Fax +46 431 851 50



www.lindab.com